

0.6mm Height 0606 Size
Full-Color Chip LEDs
Technical Data Sheet

Part No.: DL-PCB0606RGBC-C1

Double Light

◆ Features:

1. Package in 8mm tape on 7" diameter reel.
2. White package.
3. Optical indicator.
4. Colorless clear window.
5. Ideal for backlight and light pipe application.
6. Inter reflector.
7. Wide viewing angle.
8. Suitable for vapor-phase reflow, infrared reflow and wave solder processes.
9. Compatible with automatic placement equipment.
10. Available on tape and reel (12mm Tape).
11. The product itself will remain within RoHS compliant Version.

◆ Descriptions:

1. The SMD0606RGB is available in soft red, orange, yellow, green, blue and white. Due to the Package design, the LED has wide viewing angle and optimized light coupling by inter reflector, this feature makes the SMT TOP LED ideal for light pipe Application. The low current requirement makes this device ideal for portable equipment or any other application where power is at a premium.

◆ Applications:

1. Automotive: Backlight in dashboards and switches.
2. Telecommunication: Indicator and backlight in telephone and fax.
3. Indicator and backlight for audio and video equipment.
4. Indicator and backlight in office and family equipment.
5. Flat backlight for LCD's, switches and symbols.
6. Light pipe application.
7. General use.

Double Light

◆ Package Dimension:

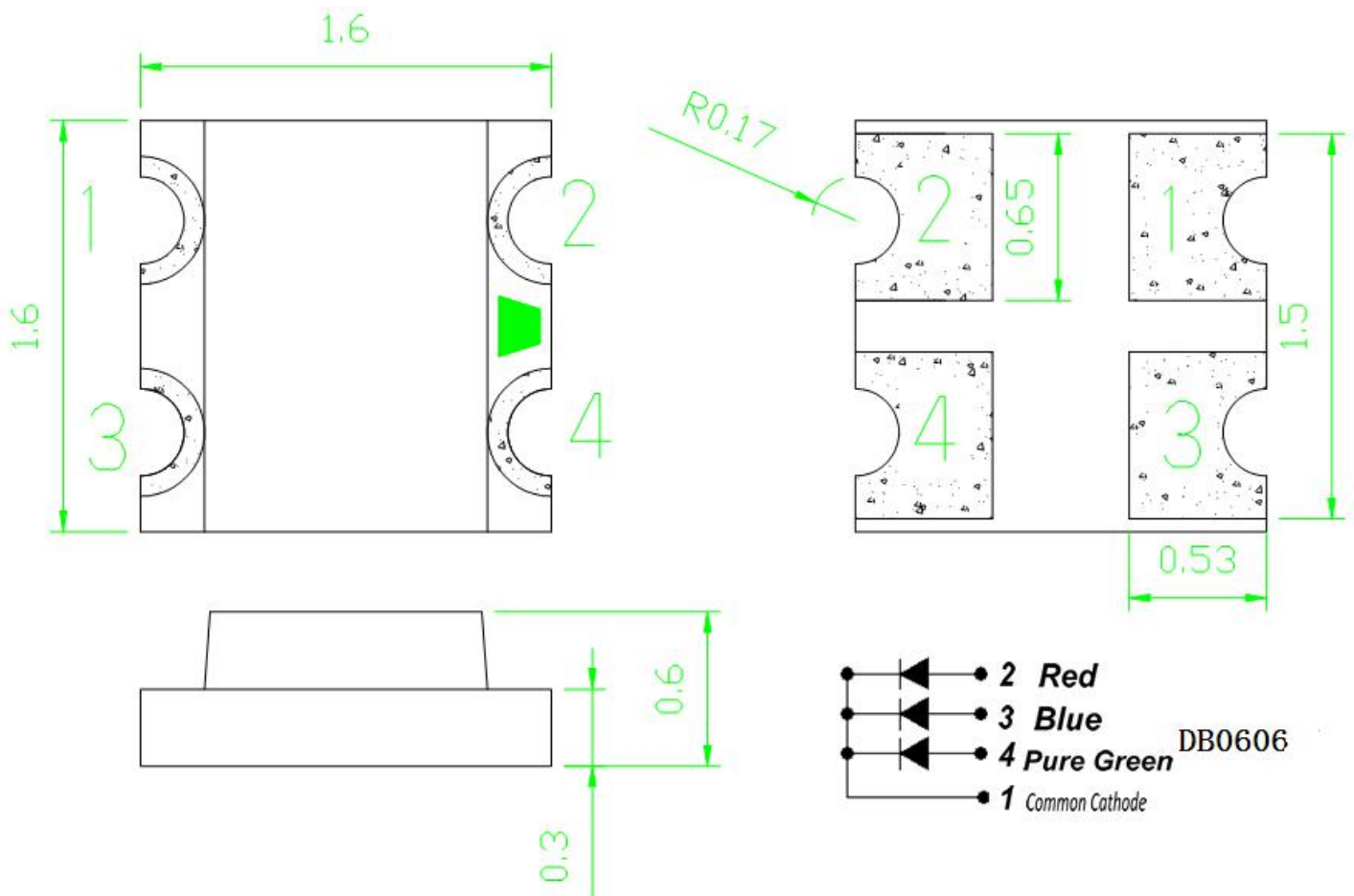

Part No.	Chip Material		Lens Color	Source Color
DL-PCB0606RGBC-C1	R	AlGaInP	Water Clear	Hyper Red
	G	InGaN		Pure Green
	B	InGaN		Blue

Notes:

1. All dimensions are in millimeters (inches).
2. Tolerance is $\pm 0.25\text{mm}$ (.010") unless otherwise specified.
3. Specifications are subject to change without notice.

Double Light

◆ Absolute Maximum Ratings at Ta=25°C

Parameters	Symbol	MAX	Unit	
Power Dissipation	PD	Hyper Red	75	mW
		Pure Green	115	
		Blue	115	
Peak Forward Current (1/10 Duty Cycle, 0.1ms Pulse Width)	IFP	Hyper Red	100	mA
		Pure Green	100	
		Blue	100	
Continuous Forward Current	IF	Hyper Red	25	mA
		Pure Green	25	
		Blue	25	
Reverse Voltage	VR	5	V	
Electrostatic Discharge (HBM)	ESD	Hyper Red	2000	V
		Pure Green	1000	
		Blue	1000	
Operating Temperature Range	Topr	-40°C to +85°C		
Storage Temperature Range	Tstg	-40°C to +100°C		
Soldering Temperature	Tsld	260°C for 5 Seconds		

Double Light

Electrical Optical Characteristics at Ta=25°C

Parameters	Symbol	Emitting Color	Min.	Typ.	Max.	Unit	Test Condition
Luminous Intensity	IV	Hyper Red	200	380	---	mcd	IF=20mA (Note 1)
		Pure Green	300	500	---		
		Blue	100	210	---		
Viewing Angle	2θ _{1/2}	Hyper Red	---	120	---	Deg	IF=20mA (Note 2)
		Pure Green	---	120	---		
		Blue	---	120	---		
Peak Emission Wavelength	λ _p	Hyper Red	---	632	---	nm	IF=20mA (Measurement @Peak)
		Pure Green	---	520	---		
		Blue	---	468	---		
Dominant Wavelength	λ _d	Hyper Red	---	624	---	nm	IF=20mA (Note 3)
		pure Green	---	525	---		
		Blue	---	470	---		
Spectral Line Half-Width	Δλ	Hyper Red	---	20	---	nm	IF=20mA
		Pure Green	---	35	---		
		Blue	---	25	---		
Forward Voltage	VF	Hyper Red	1.80	2.20	2.40	V	IF=20mA
		Pure Green	3.00	3.30	3.80		
		Blue	3.00	3.30	3.80		
Reverse Current	IR	Hyper Red	---	---	10	μA	V _R =5V
		Pure Green			50		
		Blue			50		

Notes:

1. Luminous intensity is measured with a light sensor and filter combination that approximates the CIE eye-response curve.
2. θ_{1/2} is the off-axis angle at which the luminous intensity is half the axial luminous intensity.
3. The dominant wavelength (λ_d) is derived from the CIE chromaticity diagram and represents the single wavelength which defines the color of the device.

Double Light

◆ Typical Electrical / Optical Characteristics Curves

(25°C Ambient Temperature Unless Otherwise Noted)

Hyper Red:

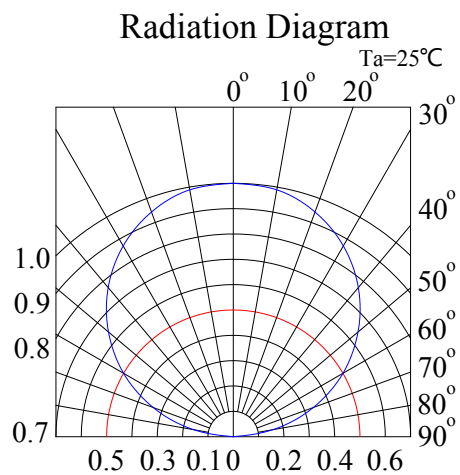
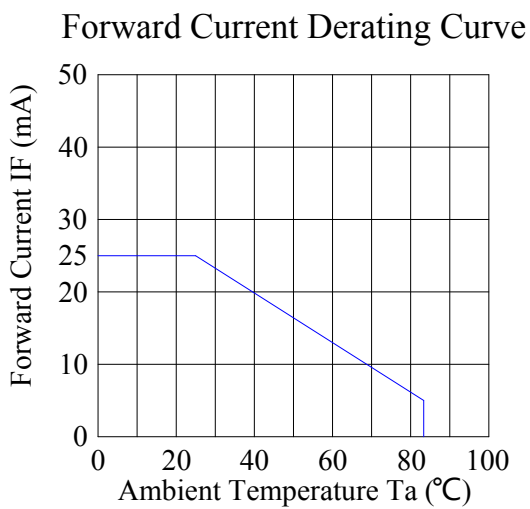
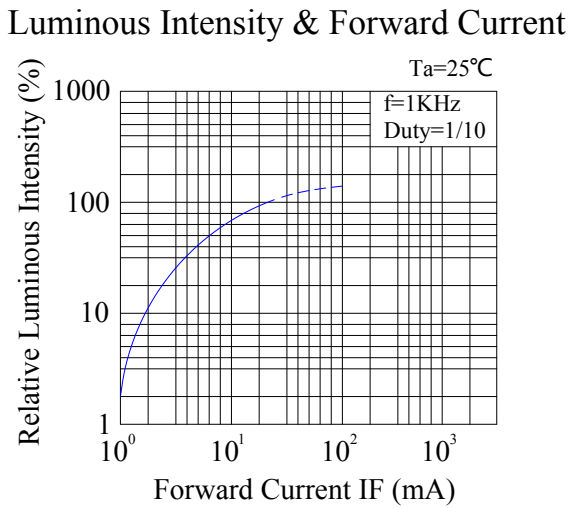
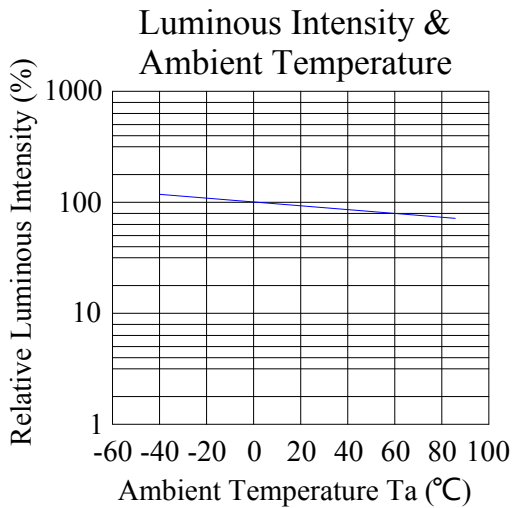
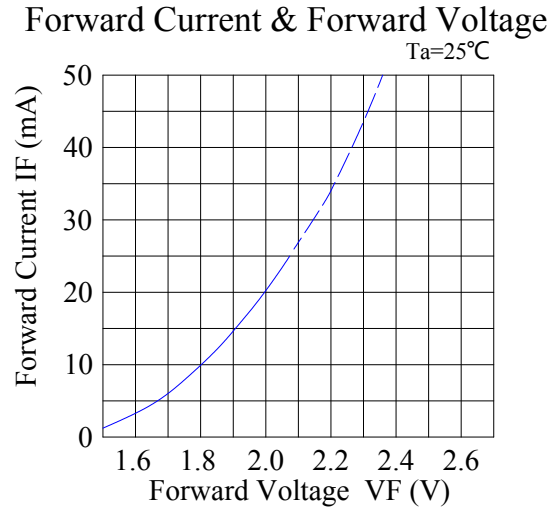
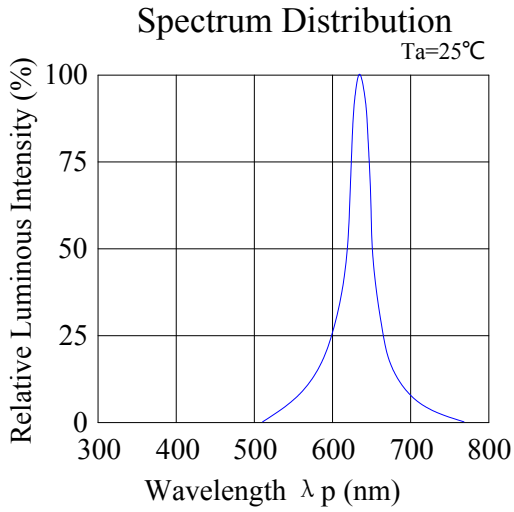

Double Light

Pure Green:

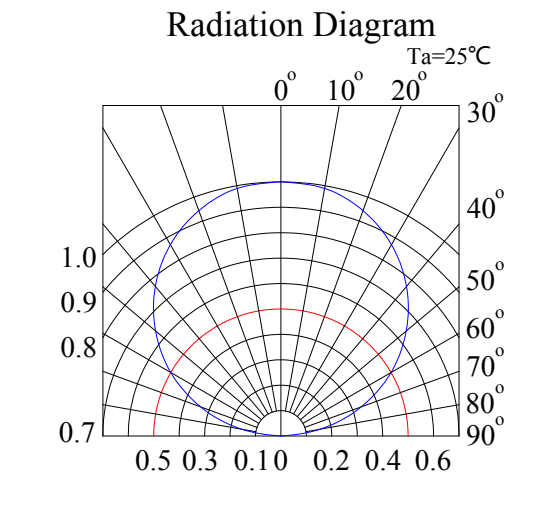
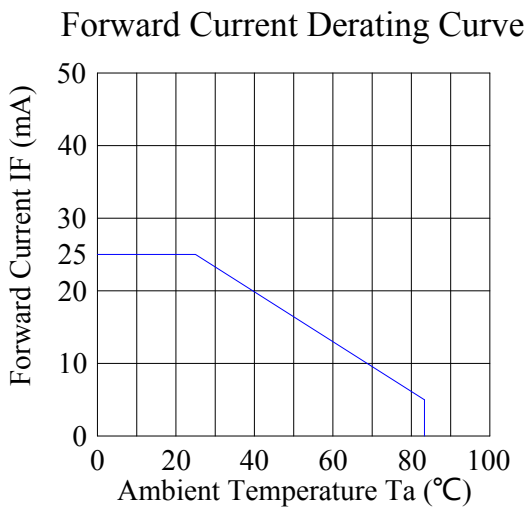
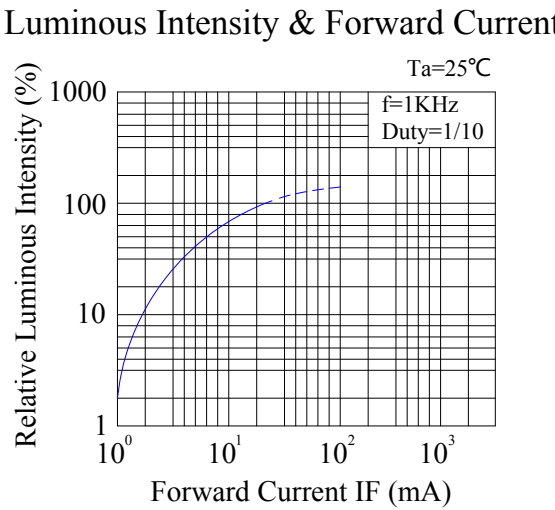
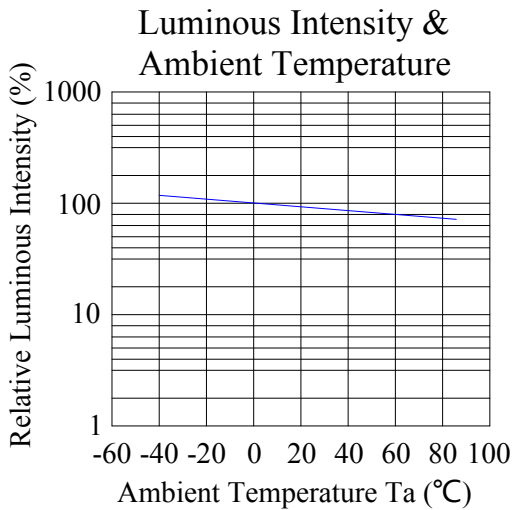
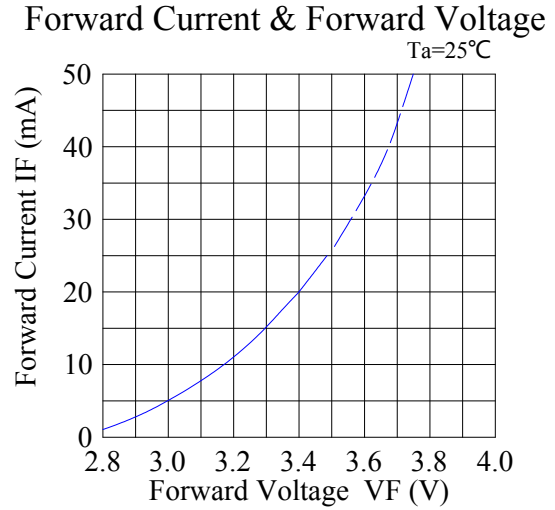
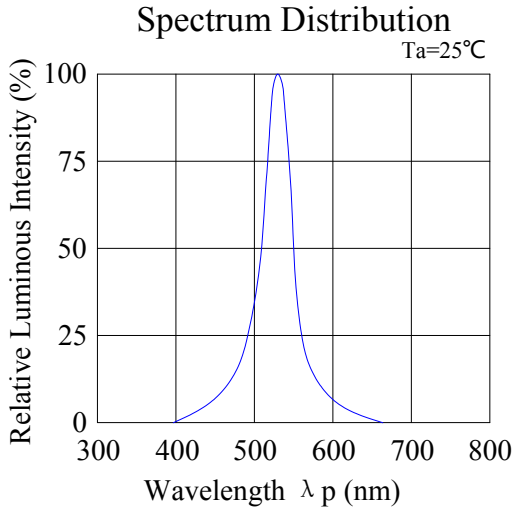

Double Light

Blue:

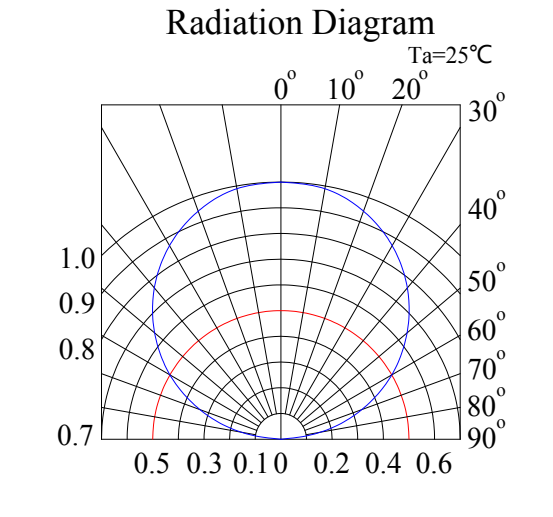
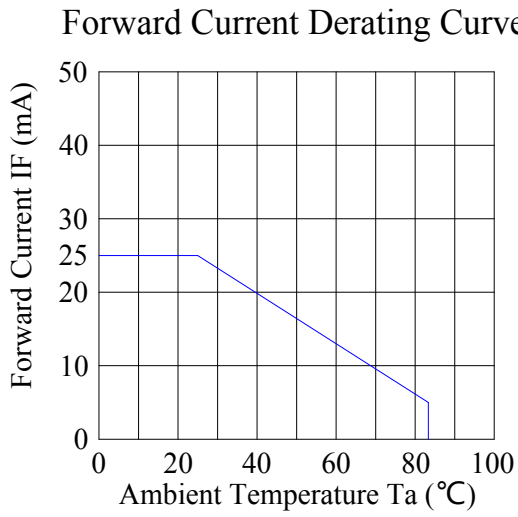
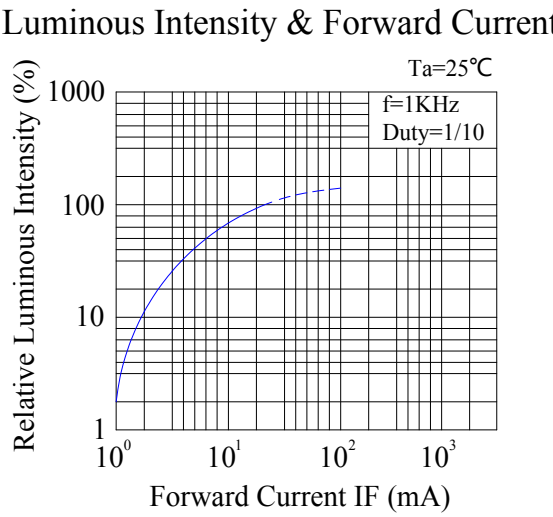
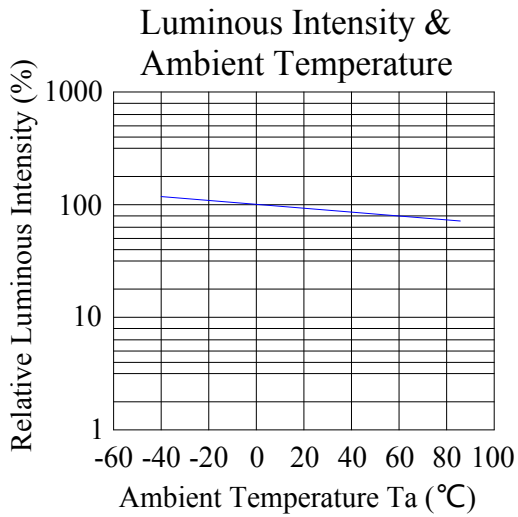
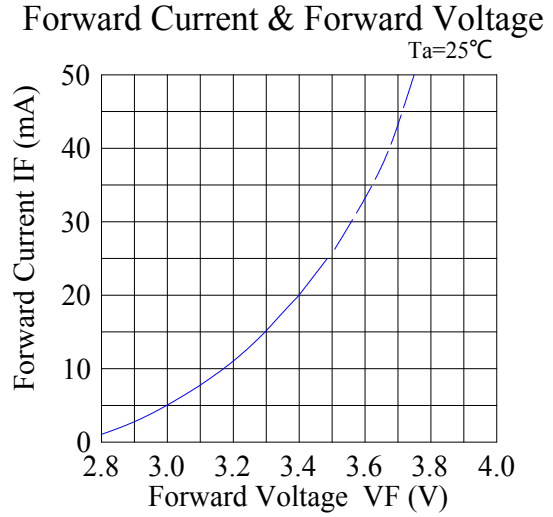
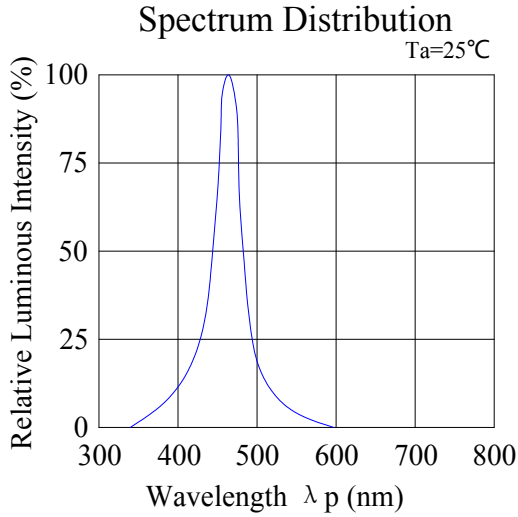

Double Light

◆ Reliability Test Items And Conditions (Per Chip):

The reliability of products shall be satisfied with items listed below:

Confidence level: 90%.

LTPD: 10%.

1) Test Items and Results:

No.	Test Item	Test Hours/Cycles	Test Conditions	Sample Size	Ac/Re
1	Resistance to Soldering Heat	6 Min	Tsld=260±5°C, Min. 5sec	25pcs	0/1
2	Thermal Shock	300 Cycles	H: +100°C 5min f 10 sec L: -10°C 5min	25pcs	0/1
3	Temperature Cycle	300 Cycles	H: +100°C 15min f 5min L: -40°C 15min	25pcs	0/1
4	High Temperature Storage	1000Hrs.	Temp: 100°C	25pcs	0/1
5	DC Operating Life	1000Hrs.	IF=20mA	25pcs	0/1
6	Low Temperature Storage	1000Hrs.	Temp: -40°C	25pcs	0/1
7	High Temperature/ High Humidity	1000Hrs.	85°C/85%RH	25pcs	0/1

2) Criteria for Judging the Damage:

Item	Symbol	Test Conditions	Criteria for Judgment	
			Min	Max
Forward Voltage	VF	IF=20mA	---	F.V.*)×1.1
Reverse Current	IR	VR=5V	---	F.V.*)×2.0
Luminous Intensity	IV	IF=20mA	F.V.*)×0.7	---

*) F.V.: First Value.

Double Light

◆ Reel Dimensions:

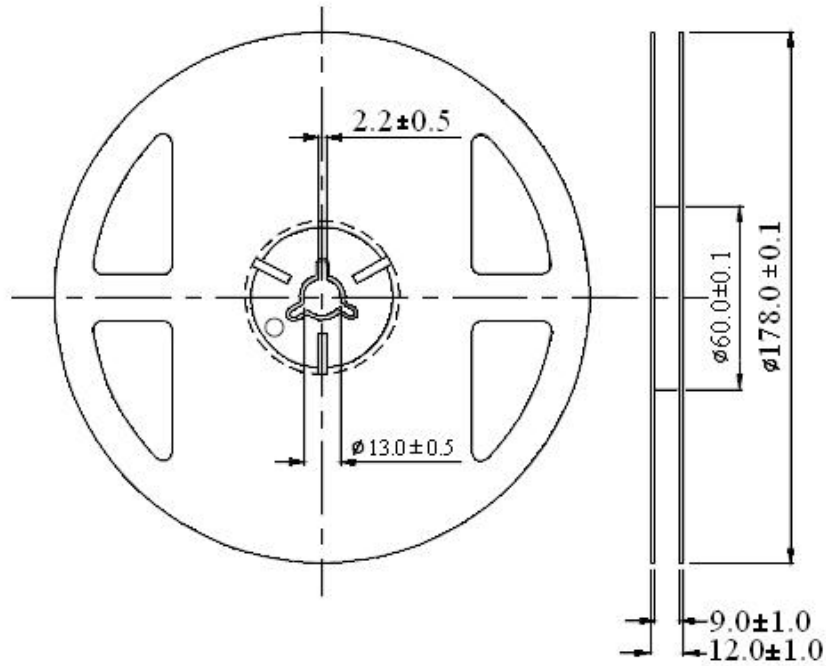

Unit: mm
Tolerance: ± 0.25 mm

◆ Carrier Tape Dimensions:

Loaded quantity 2000/3000 PCS per reel.

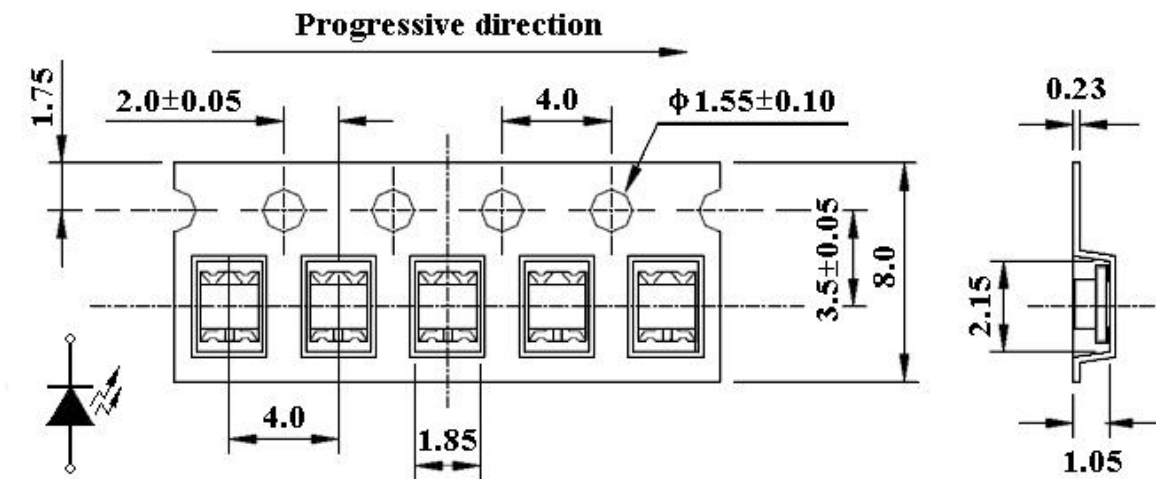

Unit: mm
Tolerance: ± 0.10 mm

Double Light

◆ Please read the following notes before using the product:

1. Over-current-proof

Customer must apply resistors for protection, otherwise slight voltage shift will cause big current change (Burn out will happen).

2. Storage

2.1 Do not open moisture proof bag before the products are ready to use.

2.2 Before opening the package, the LEDs should be kept at 30°C or less and 90%RH or less.

2.3 The LEDs should be used within a year.

2.4 After opening the package, the LEDs should be kept at 30°C or less and 70%RH or less.

2.5 The LEDs should be used within 168 hours (7 days) after opening the package.

2.6 If the moisture adsorbent material (silica gel) has fabled away or the LEDs have exceeded the storage time, baking treatment should be performed using the following conditions. Baking treatment: 60±5°C for 24 hours.

3. Soldering Condition

3.1 Pb-free solder temperature profile.

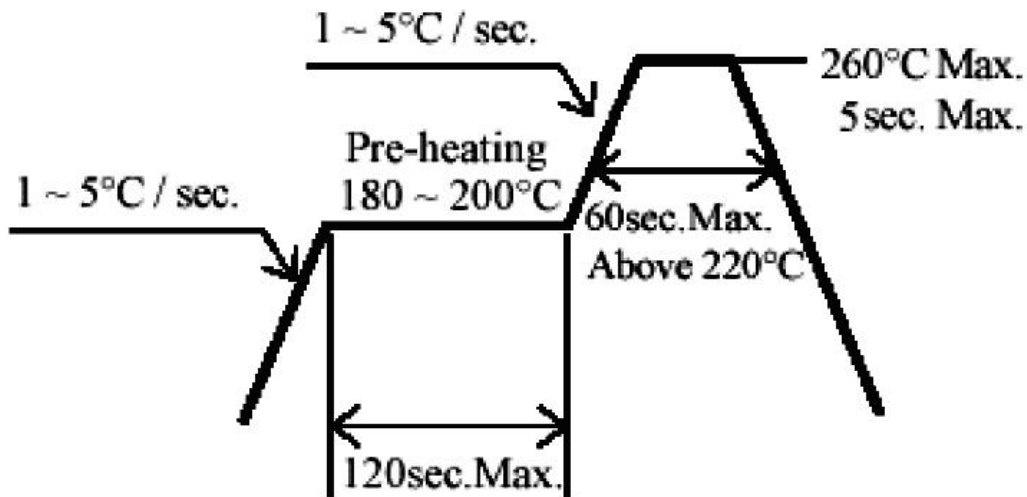

3.2 Reflow soldering should not be done more than two times.

3.3 When soldering, do not put stress on the LEDs during heating.

3.4 After soldering, do not warp the circuit board.

4. Soldering Iron

Each terminal is to go to the tip of soldering iron temperature less than 260°C for 5 seconds within once in less than the soldering iron capacity 25W. Leave two seconds and more intervals, and do soldering of each terminal. Be careful because the damage of the product is often started at the time of the hand solder.

5. Repairing

Repair should not be done after the LEDs have been soldered. When repairing is unavoidable, a double-head soldering iron should be used (as below figure). It should be confirmed beforehand whether the characteristics of the LEDs will or will not be damaged by repairing.

Double Light

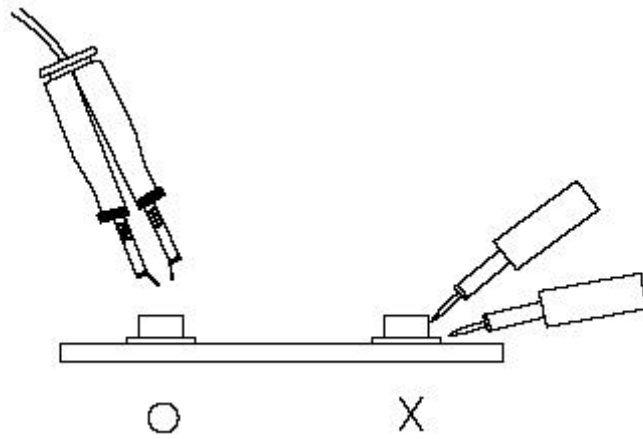

6. Caution in ESD

Static Electricity and surge damages the LED. It is recommended to use a wrist band or anti-electrostatic glove when handling the LED. All devices, equipment and machinery must be properly grounded.